

Product Details

Produktdetails | Détails du produit | Dettagli del prodotto | Detalles del producto | Productdetails | Информация о продукте | 製品詳細 | 제품 세부 정보 | 产品细节 | 產品詳細資料

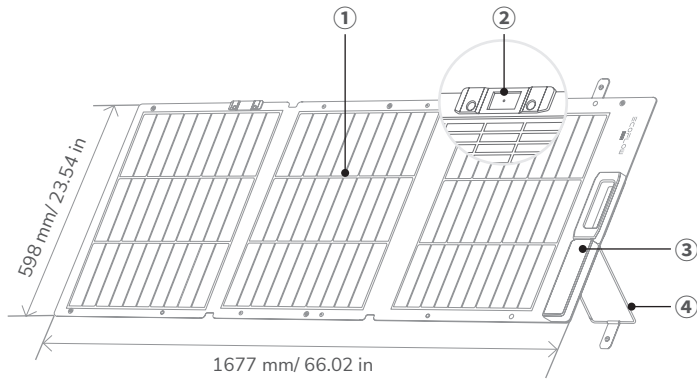

- | | | | |
|------------|---|------------|---|
| EN | ① Photovoltaic module (Front)
② Solar angle guide
③ Junction box
④ Bracket | DE | ① Photovoltaikmodul (Vorderseite)
② Solar Neigungswinkelmesser
③ Verteilerdose
④ Halterung |
| FR | ① Module photovoltaïque (face avant)
② Dispositif d'alignement solaire
③ Boîte de dérivation
④ Support | IT | ① Modulo fotovoltaico (lato anteriore)
② Guida angolare solare
③ Scatola di derivazione
④ Staffa |
| ES | ① Módulo fotovoltaico (parte delantera)
② Guía del ángulo solar
③ Caja de conexiones
④ Soporte | NL | ① Fotovoltaïsche module (voorkant)
② Zonnehoekwijzer
③ Aansluitdoos
④ Beugel |
| RU | ① Фотоэлектрический модуль (передняя сторона)
② Указатель солнечного угла
③ Электромонтажная коробка
④ Кронштейн | JP | ① 太陽光発電モジュール(表面)
② 太陽光角度測定器具
③ ジャンクションボックス
④ 架台 |
| KR | ① 태양광 모듈(전면)
② 태양광 각도 가이드
③ 정션 박스
④ 브래킷 | CHS | ① 太阳能晶板(正面)
② 角度瞄准器
③ 接线盒
④ 支撑架 |
| CHT | ① 光伏模組(正面)
② 太陽能角度導向器
③ 接線盒
④ 支架 | | |

Unfold Your Panel

Klappen Sie das Panel auf | Dépliez le panneau | Apri il pannello | Despliegue el panel | Uw paneel uitklappen | Разверните панель | ソーラーパネルを広げる | 패널 펼치기 | 展开太阳能板 | 展開面板

1

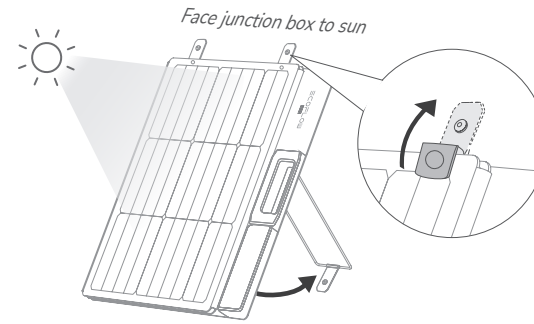

2

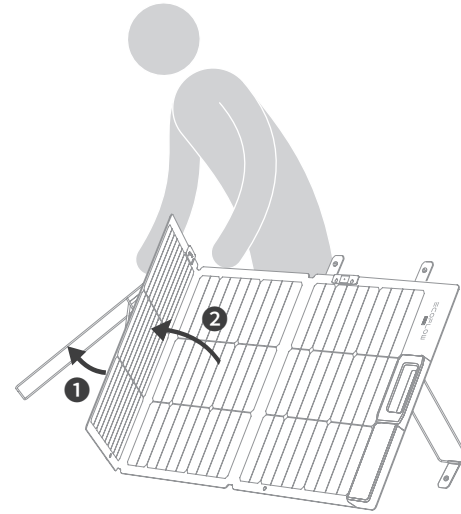

3

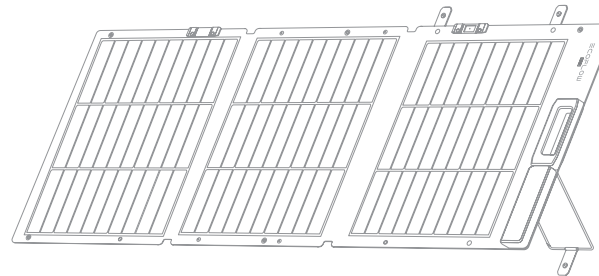

Adjust The Bracket

Passen Sie die Halterung an | Ajustez le support | Regola la staffa | Ajuste el soporte | De beugel instellen | Отрегулируйте кронштейн | ブラケットを調整する | 브래킷 조정 | 调整支架 | 調整支架

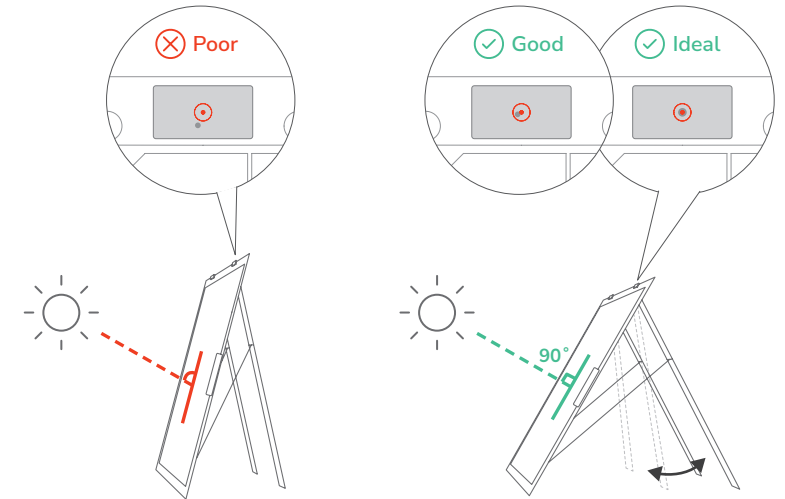

Maximize Your Power Output

Maximieren Sie die Leistungsabgabe | Maximisez la puissance de sortie | Aumenta la potenza | Maximice la salida de corriente | Uw stroomproductie maximaliseren | Увеличьте выходную мощность | 充電效率を最大限に高める | 전원 출력 최대화 | 获得更高的充电效率 | 最佳化电源输出



Optimal angle

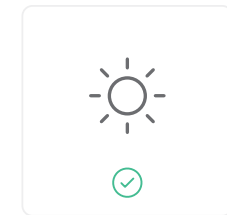

Strong sunlight



Light-colored smooth surface

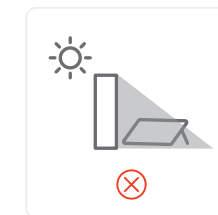

Shade

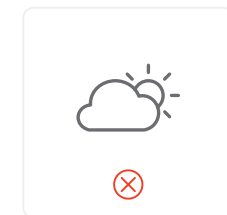

Weak sunlight

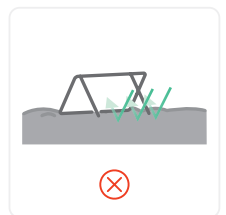

Dark-colored rough surface

Wire Your Panels

Verkabeln Sie ihre Panele | Connectez vos panneaux | Collega il pannello | Conecte sus paneles | Uw panelen aansluiten | Подключите ваши панели | 複数のソーラーパネルの接続方法 | 패널 전선 연결하기 | 连接多块太阳能板 | 為面板佈線

A In series (recommended)

Reihe | En série | In serie | En serie | In serie | Последовательное подключение | 直列接続 | 직렬 | 串联 | 串聯

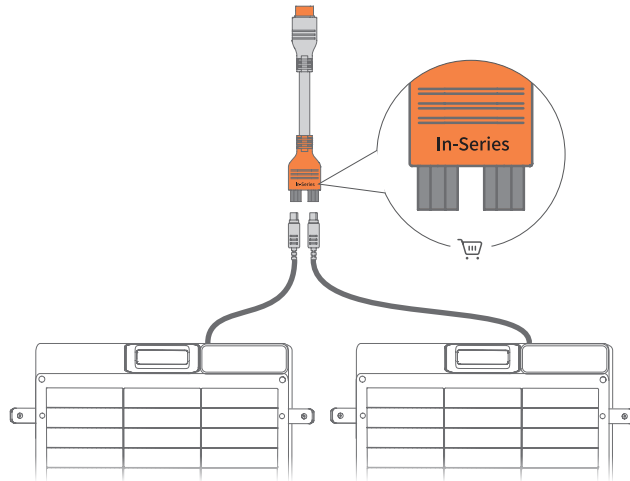

B In parallel

Parallel | En parallèle | In parallelo | En paralelo | Parallel | Параллельное подключение | 並列接続 | 병렬 | 并联 | 并聯

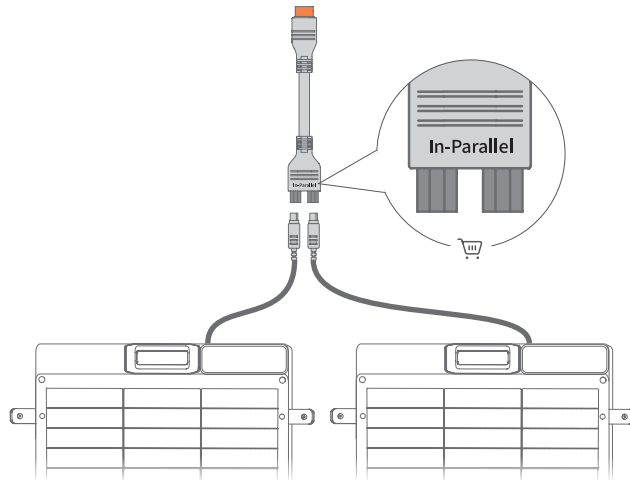

System Overview

Systemübersicht | Présentation du système | Panorámica del sistema | Descripción general del sistema | Systeemoverzicht | Обзор системы | システム概要 | 시스템 개요 | 系统概述 | 系統概覽

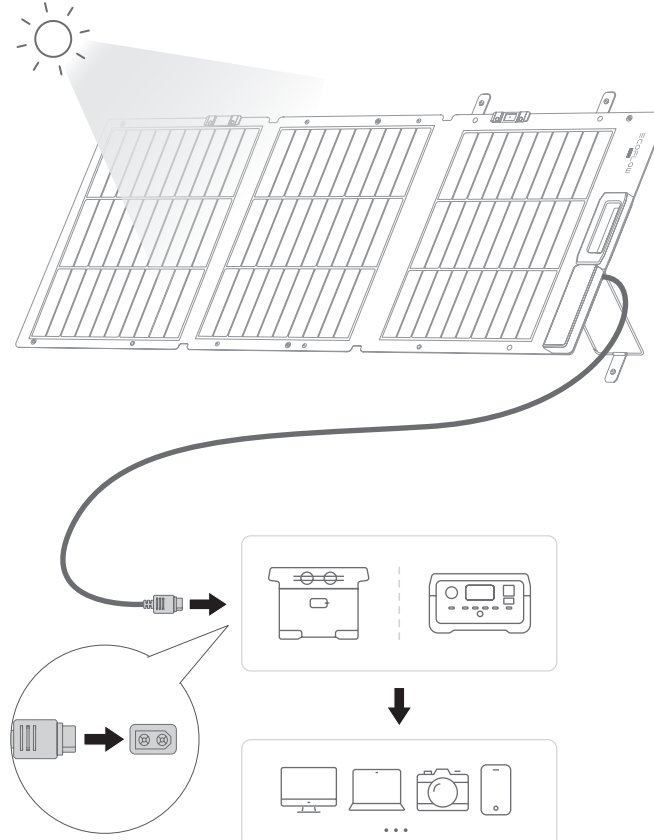

What's In The Box

Im Lieferumfang enthalten | Contenu de la boîte | Cosa contiene la confezione | Contenido | Wat zit er in de doos | Что в комплекте | 同梱物 | 구성품 | 包装清单 | 包裝內容

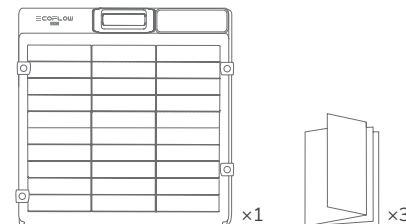

ECOFLOW

1403011202

QUICK START GUIDE

V1.0

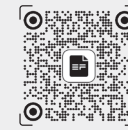
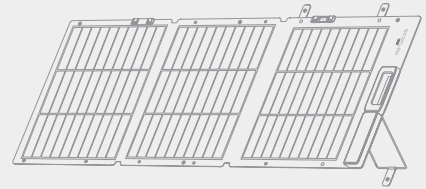

Documents

EcoFlow 160W Lightweight Portable Solar Panel

For more details, check the latest user manuals or related documents.

Q <https://www.ecoflow.com/support/download>