

LiFePO4

NovaCore 100 Ah

Lithium-Eisenphosphat-Batterien (LiFePO4)



SPEZIFIKATIONEN

Nennspannung	12,8 V
Nennkapazität	100 Ah / 1280 Wh
Innenwiderstand	≤ 20 mΩ
Effizienz	99 %
Selbstentladung	≤ 2.5 % / Monat
Max. Batterieanzahl in Reihenverschaltung	4
Max. Batterieanzahl in Parallelverschaltung	4
Zyklenlebensdauer	≥6000 bei 80 % DoD

ENTLADUNG

Max. Dauerentladestrom	150 A
Spitzenentladestrom	200 A (5 min.)
BMS-Entladeabschaltstrom	500 A ± 10 A (50 ~ 200 ms)
Empfohlene Last-Abschaltspannung	11.0 V
BMS Abschaltspannung (Entladung)	10.8 V
BMS Wiedereinschaltung (Entladung)	11.6 V
Kurzschlusschutz	200 ~500 μs

ZULÄSSIGE TEMPERATURBEREICHE

Entladung	-30 °C bis +60 °C
Ladung	-30 °C bis +45 °C
Lagerung	-5 °C bis +35 °C
BMS Cut-Off-Temperatur	+65 °C

ALLGEMEINE INFORMATIONEN

Maße (L x W x H)	(356 x 175 x 189 mm) ± 2 mm
Gewicht	11.6 kg ± 0.1 kg
Active cell balancer	5 A (max.)
Zellheizung	75 W / 5 A (max.)
Empfohlener Nachladezeitpunkt (Lagerung)	Nach 3 Monaten
Material	ABS
Schutzklasse	IP 65
Zelltyp / Chemie	Prismatisch, LiFePO4
Anschluss	DIN Batteriepol
Produktgarantie	7 Jahre
Artikelnummer	502-55004

LADUNG

Maximaler Ladestrom	100 A
Empfohlene Ladespannung	14.6 V
Float Ladespannung (Lagerung)	13.8 V
BMS Abschaltspannung (Ladung)	15.0 V
BMS Wiedereinschaltungsspannung (Ladung)	14.2 V

RICHTLINIEN

Zertifikate	CE, UN38.3, ECE R10.6 (Batterie) MSDS UL1642, IEC62133 (Zellen)
Versandklasse	UN 3480, class 9

Abmaße [mm]

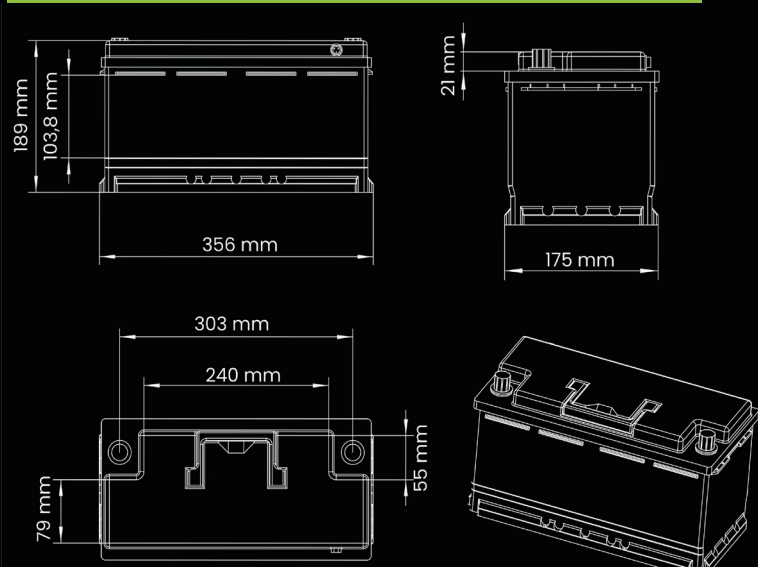

Technische Änderungen, Irrtümer und Druckfehler vorbehalten Stand 06.2025
Neueste Version stets als Download auf der Website verfügbar.

LiFePO₄

NovaCore 100 Ah

Lithium-Eisenphosphat-Batterien (LiFePO₄)



VERSCHIEDENE ENTLADEGESCHWINDIGKEITEN (25 °C)

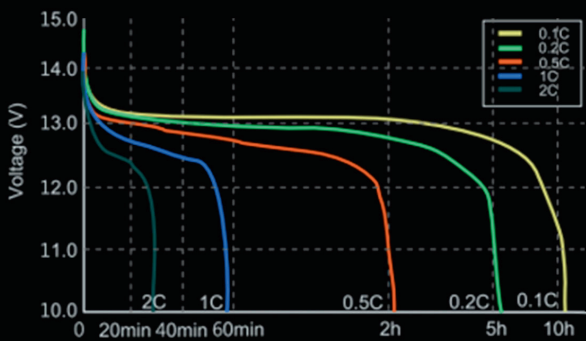

ENTLADEKURVE VERSCHIEDENE TEMPERATUREN (0.5 C)

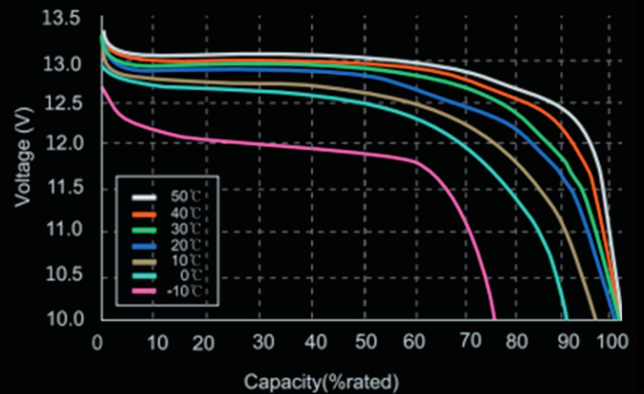

ZUSAMMENHANG LADEZUSTAND UND SPANNUNG (0.5C 25 °C)

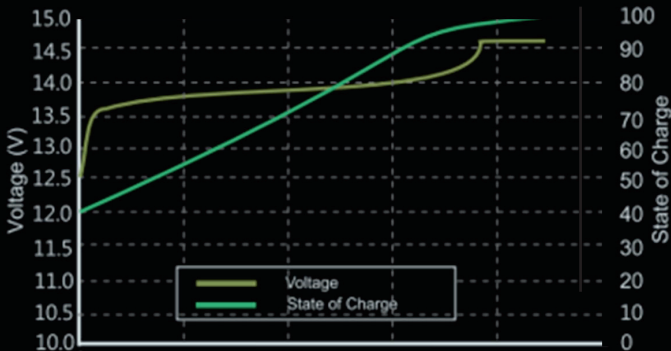

LADECHARAKTERISTIK (0.5C, 25 °C)

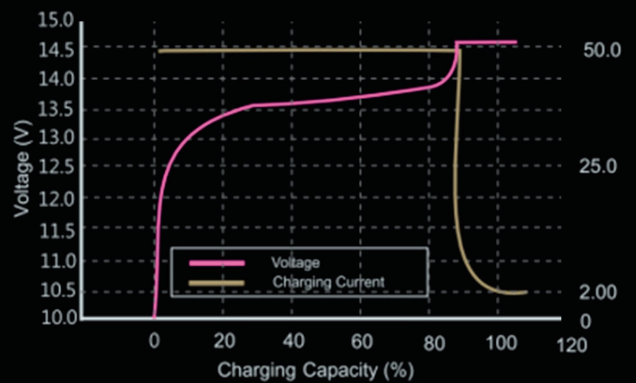

ZYKLENFESTIGKEIT IN RELATION ENTLADETIEFE

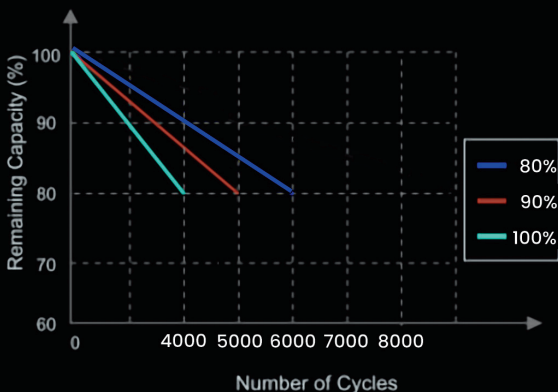

SELBSTENTLADUNG BEI VERSCHIEDENEN TEMPERATUREN

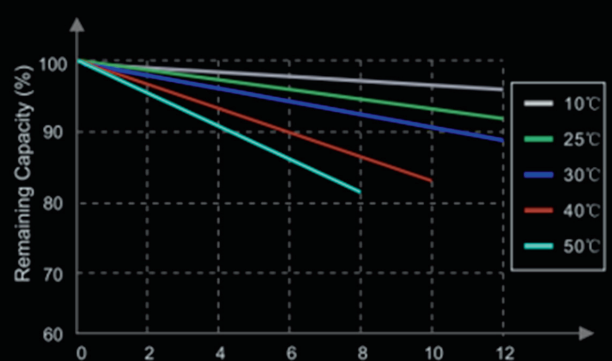

Technische Änderungen, Irrtümer und Druckfehler vorbehalten Stand 06.2025
Neueste Version stets als Download auf der Website verfügbar.

LiFePO₄

NovaCore 100 Ah

Lithium iron phosphate battery (LiFePO₄)



GENERAL SPECIFICATIONS

Nominal Voltage	12,8 V
Nominal Capacity	100 Ah / 1280 Wh
Resistance	≤ 20 mΩ
Efficiency	99 %
Self Discharge	≤ 2.5 % / Month
Maximum Batteries in Series	4
Maximum Batteries in Parallel	4
Cycle Life	≥6000 bei 80 % DoD

DISCHARGE SPECIFICATIONS

Maximum Continuous Discharge Current	150 A
Peak Discharge Current	200 A (5 min.)
BMS Discharge Cut-Off Current	500 A ± 10 A (50 ~ 200 ms)
Recommended Low Voltage Disconnect	11.0 V
BMS Discharge Voltage Cut-Off	10.8 V
BMS Reconnect Voltage (Discharging)	11.6 V
Short Circuit Protection	200 ~500 μs

TEMPERATURE SPECIFICATIONS

Discharge Temperature	-30 °C bis +60 °C
Charge Temperature	-30 °C bis +45 °C
Recommended Storage Temperature	-5 °C bis +35 °C
BMS Discharge Cut-Off Temperature	+65 °C

GENERAL INFORMATION

Dimensions (L x W x H)	(356 x 175 x 189 mm) ± 2 mm
Weight	11.6 kg ± 0.1 kg
Active cell balancer	5 A (max.)
Cell heater	75 W / 5 A (max.)
Recommended recharging time (storage)	After 3 Month
Case Material	ABS
Enclosure Protection	IP 65
Cell Type - Chemistry	Prismatic, LiFePO ₄
Terminal	DIN battery pole
Product guarantee	7 Years
Product Code	502-55004

CHARGE SPECIFICATIONS

Maximum Charge Current	100 A
Recommended Charge Voltage	14.6 V
Float Charge Voltage (Standby use)	13.8 V
BMS Charge Voltage Cut-Off	15.0 V
BMS Reconnect Voltage (Charging)	14.2 V

GUIDELINES

Certifications	CE, UN38.3, ECE R10.6 (Battery) MSDS UL1642, IEC62133 (Cells)
Shipping Classification	UN 3480, class 9

DIMENSIONAL SPECIFICATIONS [mm]

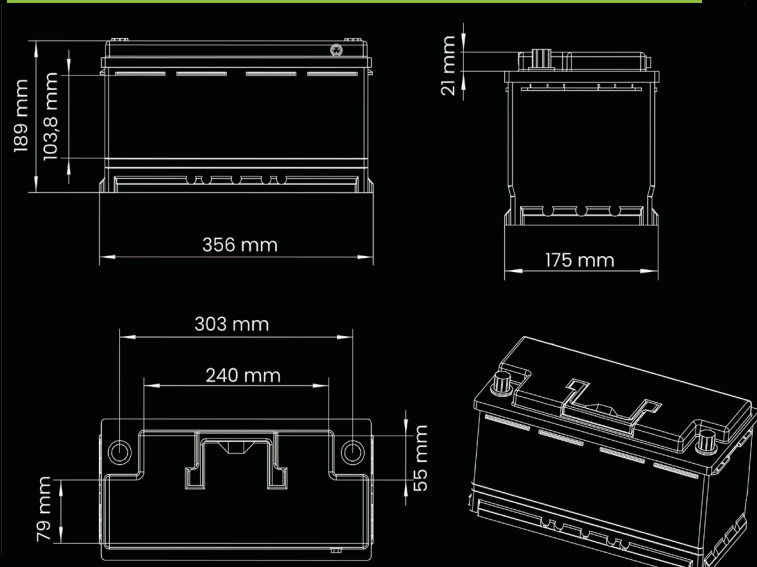

Technical changes, errors and misprints reserved Stand 06.2025
The latest version is always available for download on the website.

LiFePO4



NovaCore 100 Ah

Lithium iron phosphate battery (LiFePO4)



DIFFERENT RATE DISCHARGE CURVE (25 °C)

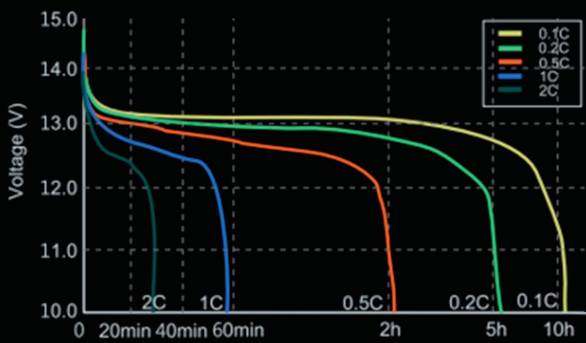

DIFFERENT TEMPERATURE DISCHARGE CURVE (0.5 C)

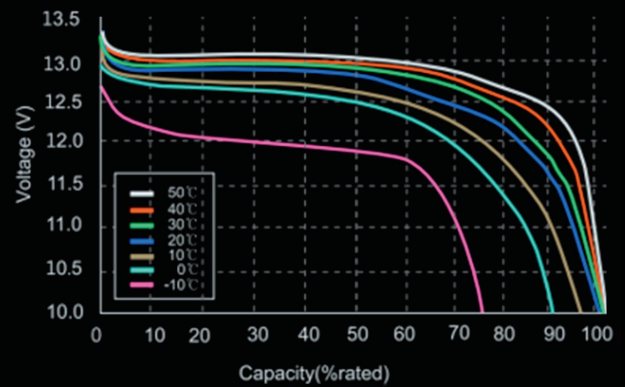

STATE OF CHARGE CURVE (0.5C 25 °C)

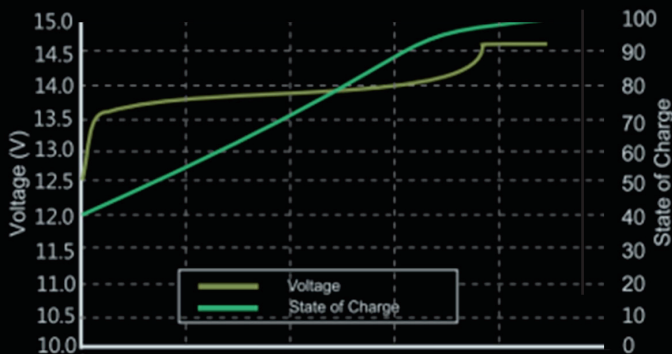

CHARGING CHARACTERISTICS (0.5C, 25 °C)

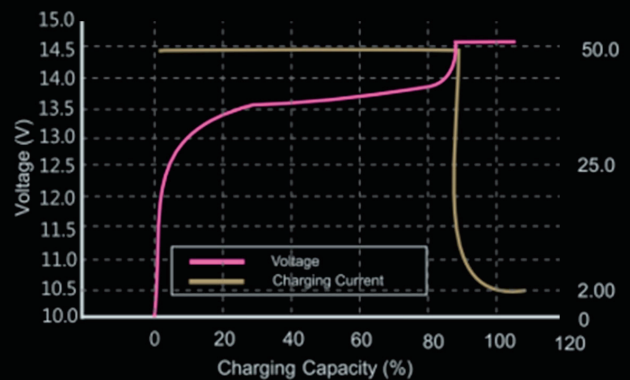

CYCLE LIFE IN RELATION TO DEPTH OF DISCHARGE

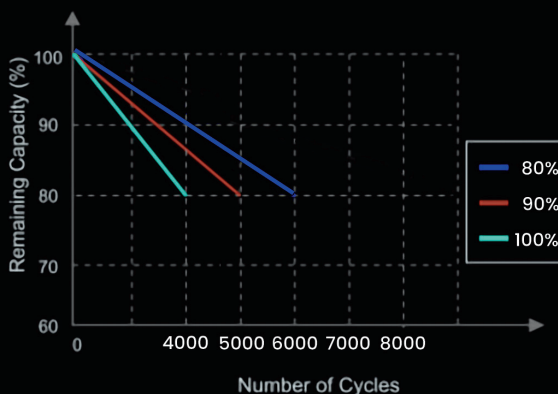

DIFFERENT TEMPERATURE SELF DISCHARGE CURVE

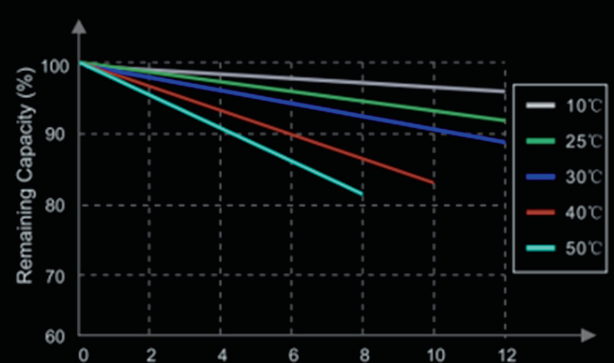

Technical changes, errors and misprints reserved Stand 06.2025
The latest version is always available for download on the website.